

B: Inside piece (Silver)
*VALVE mark on the rear side

D: Inside piece (Gold)

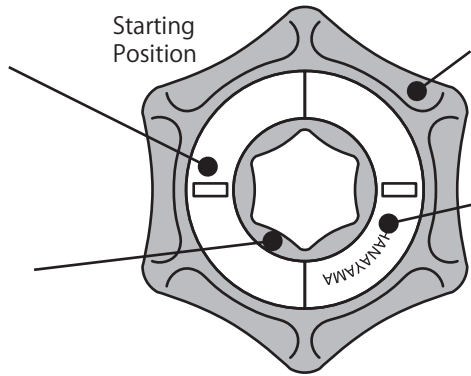

A: Outside piece (Gold)

C: Outside piece (Gold)
*with HANAYAMA mark

① While holding it as illustrated below, rotate D leftwards. When it is rotated, B and C are hooked and rotate together.

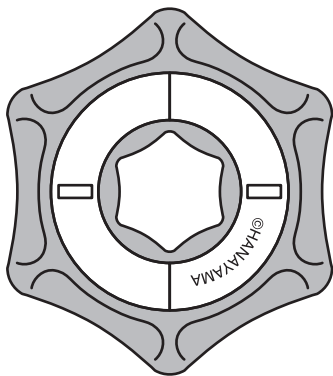

② Keep rotating so that the tops of A and D are aligned.

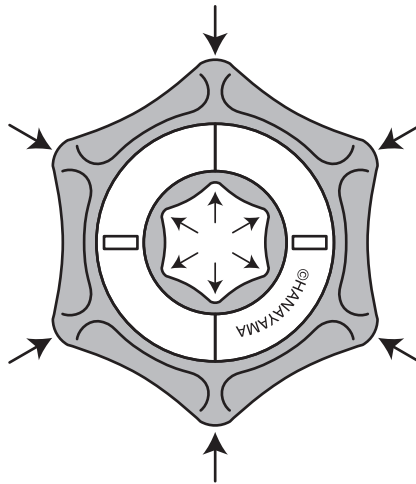

③ There is a position where, out of the 6 tops, C slides to the bottom.
*A star mark (★) is given as a guide.

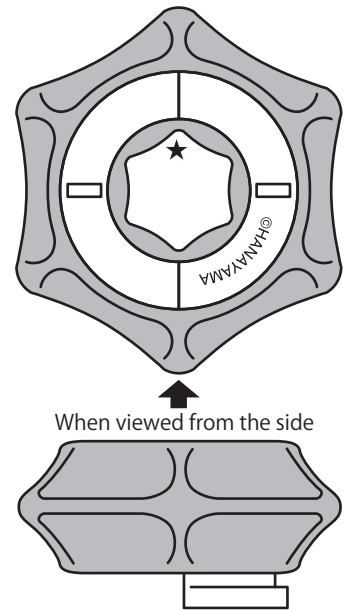

④ From the position in ③, rotate only D leftwards until it stops, and place on the table so that D rises.

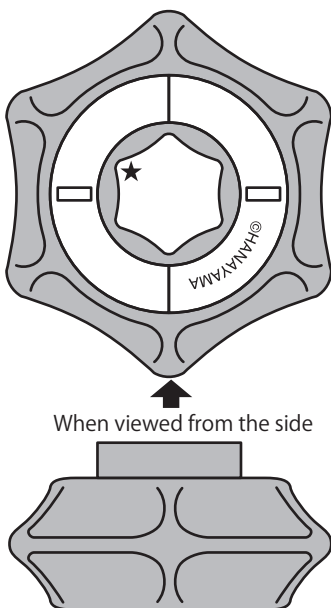

⑤ Rotate B, C and D leftwards to the positions shown below, and lift up so that D falls.

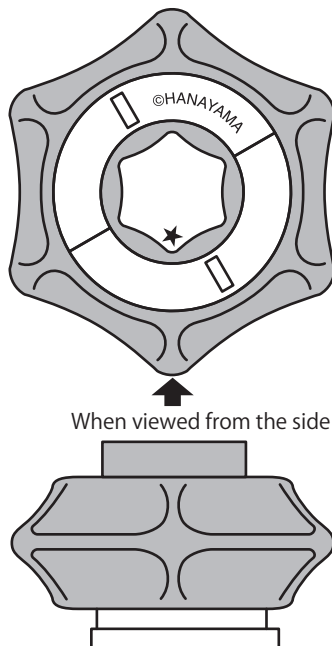

⑥ Rotate only D rightwards to the position shown below so that D falls.

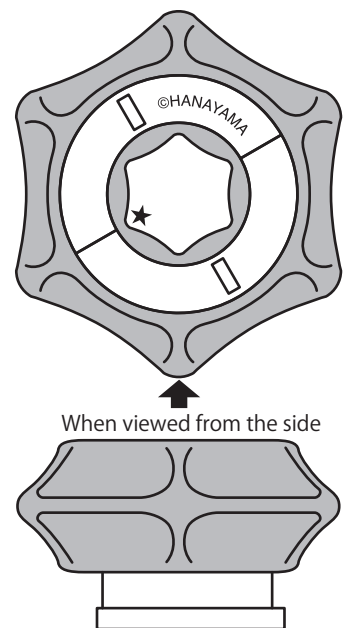

⑦ Rotate B, C and D together rightwards to the positions shown below so that D and C fall.

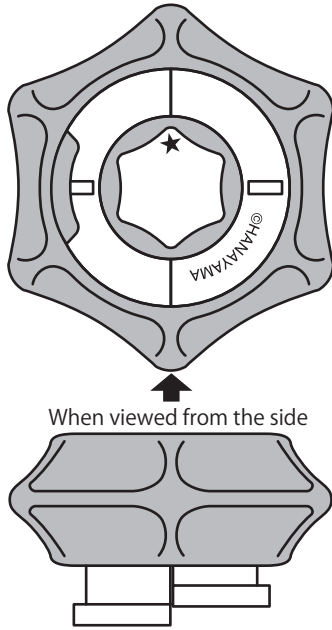

⑧ Rotate only D leftwards to the position shown below so that D and C fall even further.

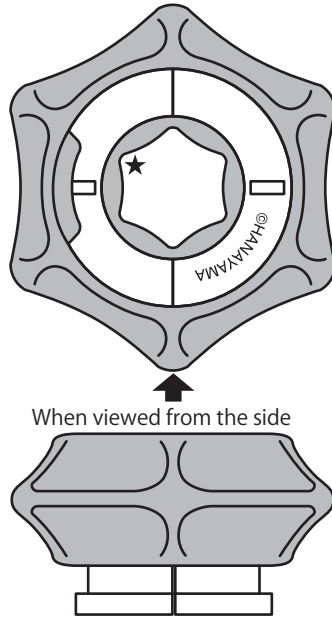

⑨ Rotate B, C and D together leftwards to the positions shown below so that B falls even further.

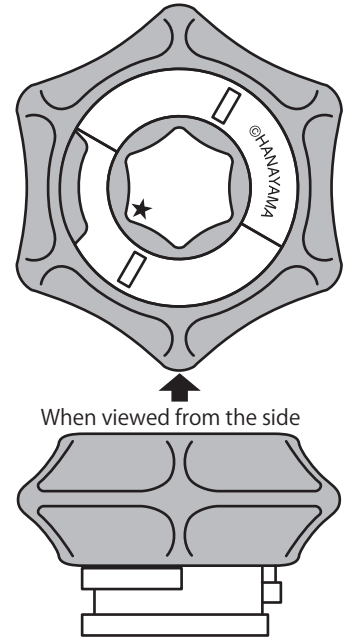

⑩ Rotate only D rightwards to the position shown below so that B, D and C detach.

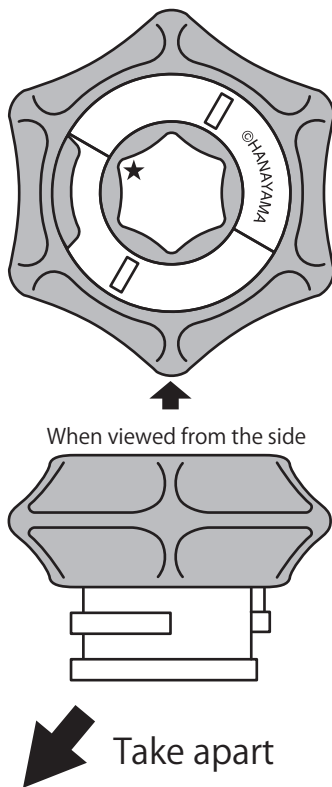

■ How to reassemble

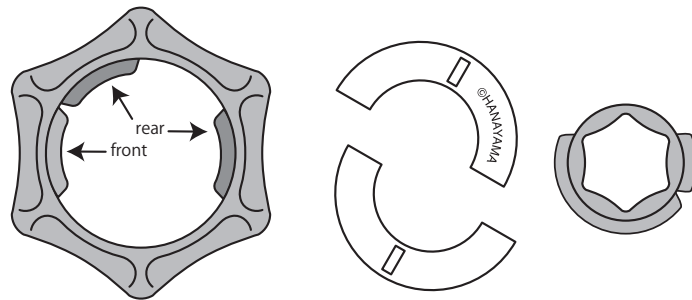

Make this set

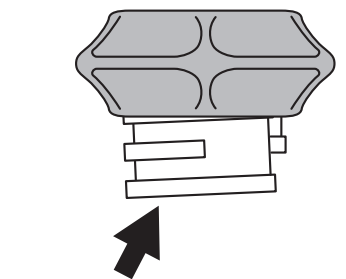
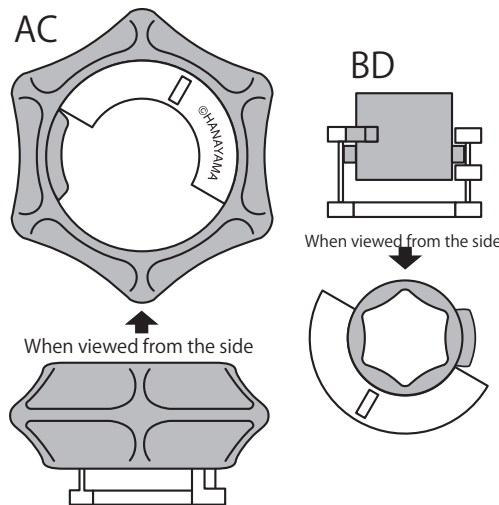

Assemble the BD and AC sets as shown on the left. Restore in the reverse procedure to that when disassembling.